



Worldwide Distributor and Brand Owner
Anderson and Worthington Building Supplies Ltd
28 A, Church Road, Stanmore, HA7 4AW, UK

www.neoelectrical.co.uk

Our distributor / stockist



**BE SAFER.
BE SMARTER.**

2021 - 22 LV ELECTRIC RANGE



INTRODUCTION

Lights are key to the décor and safety of homes. Neox offers a wide variety of electrical, lighting and accessories that have been developed to meet the rising demand in the region. Neox's extensive lighting and electrical range consists of the latest modern innovations, which bear the highest quality standards and follow stringent quality control measures before they arrive in the market.

Service excellence, product quality, constant customer support and innovation are the core areas for Neox and continue to be the foundation as it aims to grow and offer more choice to its customers in the coming years.

- Approvals: ESMA, CE, G-mark, TSC, ROHS
- Material composition: Virgin plastic and high-quality copper
- Availability: UAE, Bahrain, Oman and Qatar
- Origin: In Asia across various locations

While Neox remains committed to developing quality products and providing outstanding services, it is the wide array of products that the brand offers, which is certain to suit everyone's taste and needs.



THE PREFERRED CHOICE. A TRUSTED BRAND

Neox is always evolving to continuously bring new products as per current and future market requirements.

Aquaplex is the only exclusive importer for Neox electrical products from Anderson & Worthington Building Supplies for MENA (Middle East North African) region. Anderson and Worthington Building Supplies is a leading British distributor and manufacturer of plumbing and electric supplies, being home to some of the top names in the MEP industry as - Neox, Rhino, G-Fix, and Asahi.

Neox range of products comply with international quality standards and are certified by ESMA, G Mark & ECAS.



With a network of 500+ plumbers, DIY electrical merchants, the company offers these brands not only in the UK, but in all countries in the Middle East, as well as in India through its exclusive distributor - Aquaplex.

PRESENTING PRODUCTS

"The path of success achieved through visualization, satisfaction, and implementation makes the corporation great" With this vision, our management is looking forward to reaching the maximum customers across the geographies with benchmark products and services. More importantly, we intend to continue this tradition and improve our already distinguished reputation with hard work and dedication.

YOUR SAFETY IS PRIORITY





FEATURES & BENEFITS

Neox, provides unmatched safety, convenience and reliability. Apart from innovation and class, the name stands for quality, services, integrity and dependability. With that, the brand focuses on delivering excellent customers service to ensure the satisfaction of every single client. Vigorous testing methods have certified that its vast range of products is at par with excellence to match international quality standards of energy efficiency and safety across all the verticals.



Nature Friendly



CONTENT

PRODUCTS CATEGORY

● PVC CABLE TRUNKING	08
● CEILING FANS	10
● PVC ELECTRICAL INSULATION TAPE	12
● LED LIGHTS, PANELS AND LED BULBS	14
● GALVANIZED STEEL SWITCH & SOCKET BOX	22
● SWITCHES AND WIRING ACCESSORIES	24
● EXTENSION TRAILING SOCKETS	30
● WEATHERPROOF SERIES IP55 SWITCHES AND SOCKETS	34
● WEATHERPROOF SERIES IP66 SWITCHES AND SOCKET OUTLETS	38
● WEATHERPROOF IP66 ISOLATOR SWITCHES	41

PVC CABLE TRUNKING

PVC CABLE TRUNKING

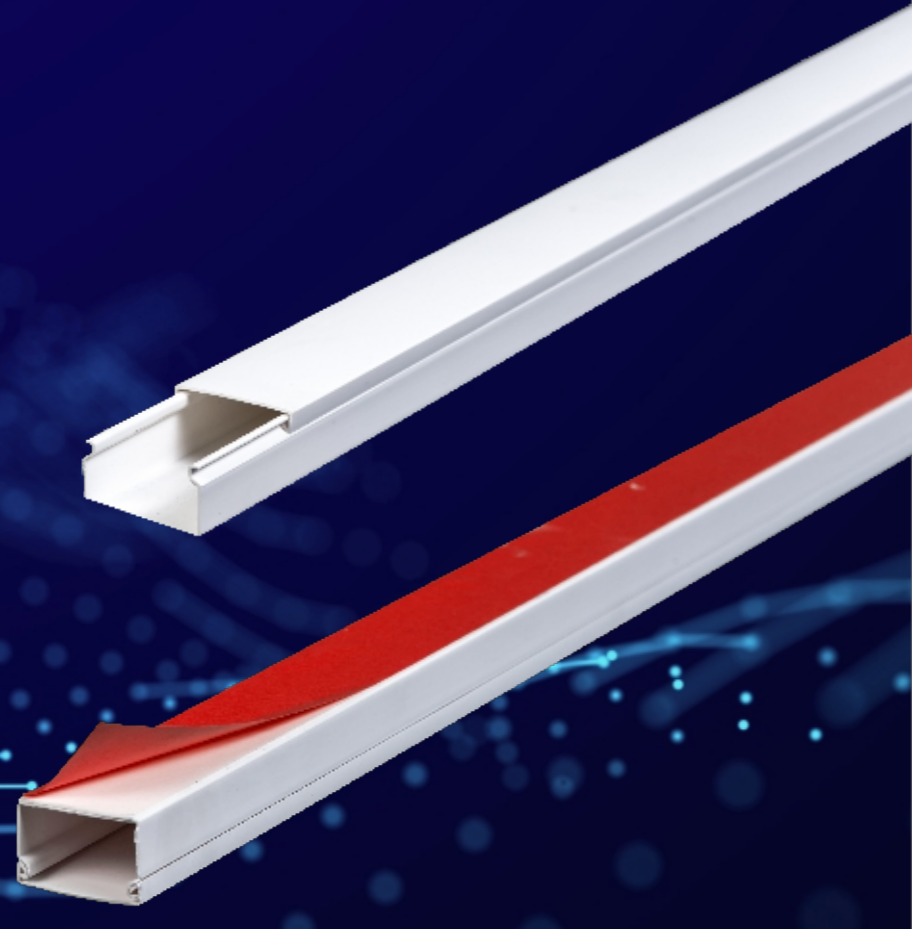

FEATURES:

- Wide range of trunking profiles.
- Unobtrusive and neat.
- Easy to assemble and install.
- Durable and impact resistant
- Self-adhesive options allow fast installation

PVC CABLE TRUNKING



Code	Description	Max Temp	Length	Master Carton
NEOZBPK40025	PVC CABLE TRUNKING	80°C/176°F	40mm x 25mm x 2,9mtr	01 Bundle-15Len

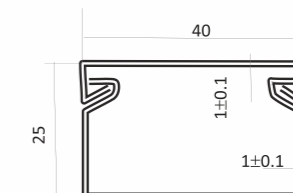

Code	Description	Max Temp	Length	Master Carton
NEOZBPK16116	PVC CABLE TRUNKING WITH SELF ADHESIVE	80°C/176°F	16mm x 16mm x 2,9mtr	01 Bundle-40Len

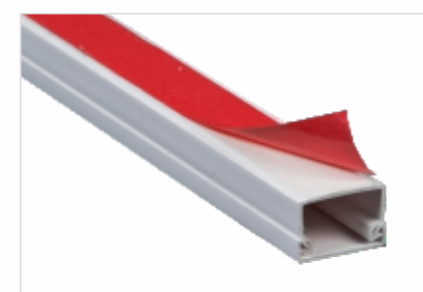
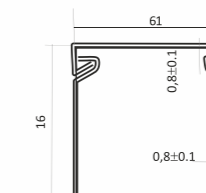

Code	Description	Max Temp	Length	Master Carton
NEOZBPK25116	PVC CABLE TRUNKING WITH SELF ADHESIVE	80°C/176°F	25mm x 16mm x 2,9mtr	01 Bundle-30Len

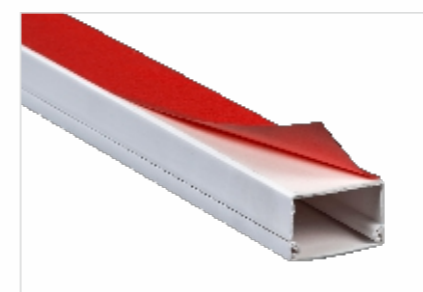
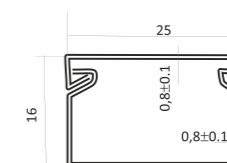

Code	Description	Max Temp	Length	Master Carton
NEOZBPK40125	PVC CABLE TRUNKING WITH SELF ADHESIVE	80°C/176°F	40mm x 25mm x 2,9mtr	01 Bundle-15Len

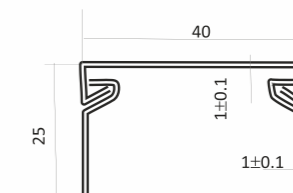

MADE IN TURKEY

CEILING FANS



FEATURES:

- 3-Blade design
- 5 Speed Control
- 56 Inches (1,400mm) blade span
- 100 % Pure Copper Motor
- Durable Double Condenser Ball Bearing Motor for extra smooth and silent operation
- Corrosion Resistance Aluminium Blades for better air delivery
- 2 YEARS WARRANTY.

CEILING FANS



CEILING FANS



Colour : White



Colour : Ivory

Code	Size	Material	RPM	Watt	Air Delivery	Colour
NEONXZ2929EWH	56"	MS	280	80W	210 m3/mint	White
NEONXZ2929EIV	56"	MS	280	80W	210 m3/mint	Ivory



PVC ELECTRICAL INSULATION TAPE



FEATURES:







- Excellent resistance to corrosion
- Easy to cut for a special process in the side of the tape
- Temperature resistance and can withstand harsh temperature up to 80°
- Environment friendly pressure sensitive adhesive
- Available in 7 colours

PVC ELECTRICAL INSULATION TAPE



PVC ELECTRICAL INSULATION TAPE



	Code	Description	Size	Colour	Master Carton
	NEONX103YE	PVC ELECTRICAL TAPE	0.13mmX19mmX10yard	Yellow	01 Box - 500 Roll
	NEONX103WH	PVC ELECTRICAL TAPE	0.13mmX19mmX10yard	White	01 Box - 500 Roll
	NEONX103ST	PVC ELECTRICAL TAPE	0.13mmX19mmX10yard	Yellow/ Green Stripes	01 Box - 500 Roll
	NEONX103RE	PVC ELECTRICAL TAPE	0.13mmX19mmX10yard	Red	01 Box - 500 Roll
	NEONX103GR	PVC ELECTRICAL TAPE	0.13mmX19mmX10yard	Green	01 Box - 500 Roll
	NEONX103BL	PVC ELECTRICAL TAPE	0.13mmX19mmX10yard	Blue	01 Box - 500 Roll
	NEONX103BK	PVC ELECTRICAL TAPE	0.13mmX19mmX10yard	Black	01 Box - 500 Roll

LED LIGHT - BULBS

SAVES
80%
ENERGY

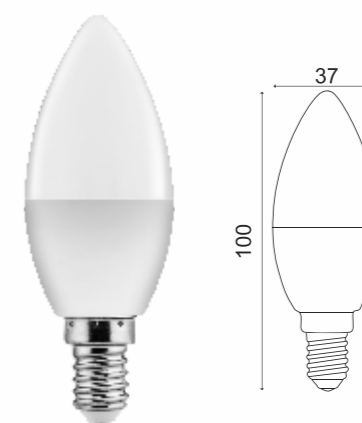

Code	Dimension	Watt	Colour Temperature	Total Lumen	Voltage	Material	Master Carton	SAMSUNG LED & 02 Years Warranty
NEOLMI01006W6500K	37mmX100mm	6W	6500K	480LM	175-265V	Plastic+Aluminium	1 Box - 100 Pcs	
NEOLMI01006W3000K	37mmX100mm	6W	3000K	480LM	175-265V	Plastic+Aluminium	1 Box - 100 Pcs	

LED SPOT LIGHT

SAVES
80%
ENERGY



Code	Dimension	Watt	Colour Temperature	Total Lumen	Voltage	Material	Master Carton	SAMSUNG LED & 02 Years Warranty
NEOLRF02808W6500K	50mmX55mm	8W	6500K	640LM	175-265V	Plastic+Aluminium	1 Box - 100 Pcs	
NEOLRF02808W3000K	50mmX55mm	8W	3000K	640LM	175-265V	Plastic+Aluminium	1 Box - 100 Pcs	

LED T8 FULL GLASS TUBELIGHT

SAVES
80%
ENERGY

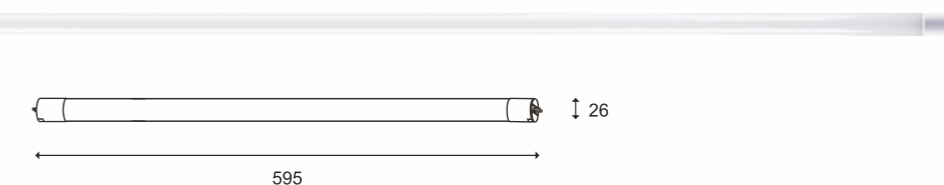

Code	Dimension	Watt	Colour Temperature	Total Lumen	Voltage	Material	Master Carton	SAMSUNG LED & 02 Years Warranty
NEOLTB80609W6500K	26mmX595mm	9W	6500K	900LM	175-265V	LED Full glass tube	1 Box - 25 Pcs	
NEOLTB806018W6500K	26mmX1195mm	18W	6500K	1800LM	175-265V	LED Full glass tube	1 Box - 25 Pcs	



LED LIGHT - BULBS

LED LIGHT - BULBS



SAVES
80%
ENERGY



FEATURES:

- Lights up instantly
- More than 85% energy savings over incandescent bulbs
- Reduce thermal losses
- Shock proof and vibration proof
- Environmentally Friendly

Code	Dimension	Watt	Colour Temperature	Total Lumen	Voltage	Material	Master Carton	SAMSUNG LED & 02 Years Warranty
NEOLBL08407W3000K	60mmX106mm	7W	3000K	630LM	175-265V	Plastic+Aluminium	1 Box 100 Pcs	
NEOLBL08407W6500K	60mmX106mm	7W	6500K	630LM	175-265V	Plastic+Aluminium	1 Box 100 Pcs	
NEOLBL08409W3000K	60mmX106mm	9W	3000K	810LM	175-265V	Plastic+Aluminium	1 Box 100 Pcs	
NEOLBL08409W6500K	60mmX106mm	9W	6500K	810LM	175-265V	Plastic+Aluminium	1 Box 100 Pcs	
NEOLBL084011W3000K	60mmX110mm	11W	3000K	990LM	175-265V	Plastic+Aluminium	1 Box 100 Pcs	
NEOLBL084011W6500K	60mmX110mm	11W	6500K	990LM	175-265V	Plastic+Aluminium	1 Box 100 Pcs	
NEOLBL084015W3000K	65mmX130mm	15W	3000K	1350LM	175-265V	Plastic+Aluminium	1 Box 50 Pcs	
NEOLBL084015W6500K	65mmX130mm	15W	6500K	1350LM	175-265V	Plastic+Aluminium	1 Box 50 Pcs	

SAVES
80%
ENERGY

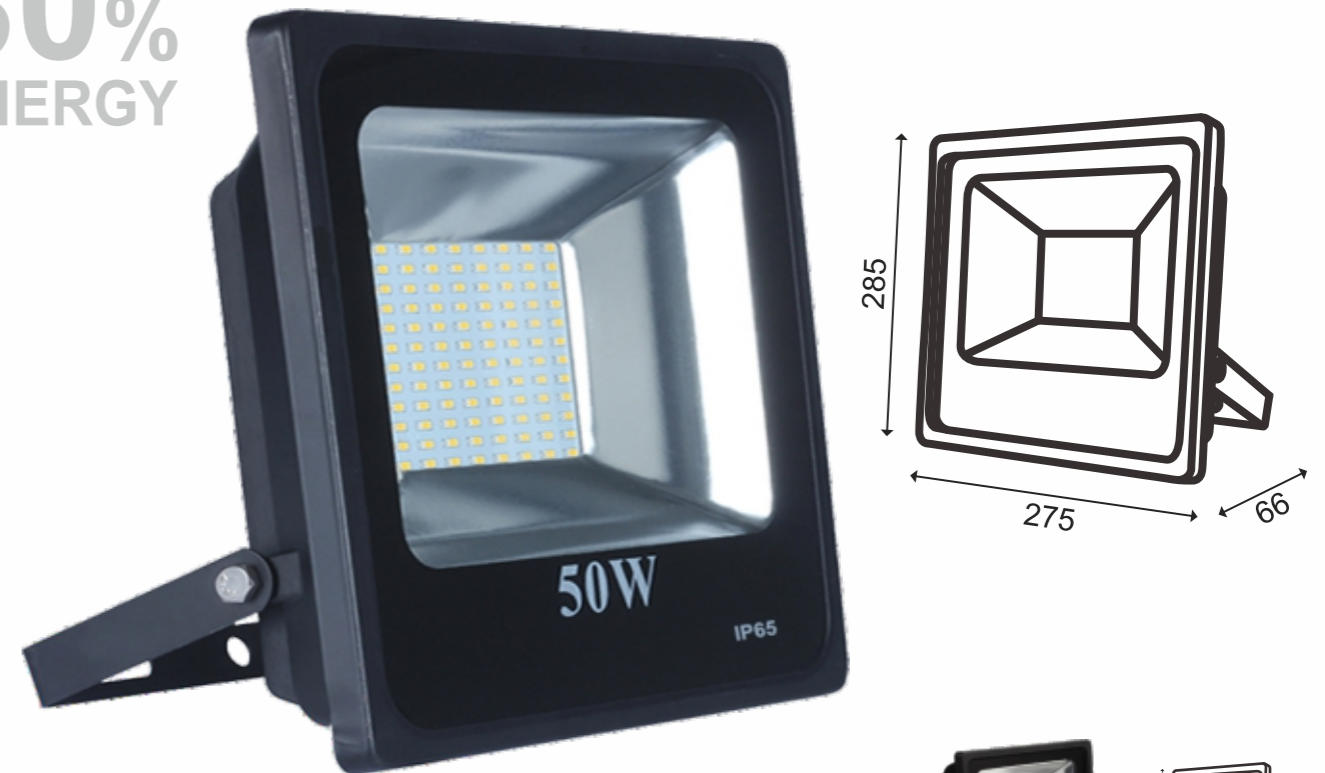

FEATURES:

- Available from 50w – 400w
- Premium quality aluminium alloy body
- High power LED chip
- Built in power supply
- IP65 rating



Code	Dimension	Watt	Colour Temperature	Total Lumen	Voltage	Material	Master Carton	02 Years Warranty
NEOLTFP50W6500K	285mm x 275mm x 66mm	50W	6500K	4250LM	175-265V	Dia casting aluminum	1 Box 12 Pcs	
NEOLTFP100W6500K	293mm x 293mm x 85mm	100W	6500K	8500LM	175-265V	Dia casting aluminum	1 Box 5 Pcs	
NEOLTFP150W6500K	336mm x 317mm x 85mm	150W	6500K	12750LM	175-265V	Dia casting aluminum	1 Pcs	
NEOLTFP200W6500K	385mm x 395mm x 110mm	200W	6500K	17000LM	175-265V	Dia casting aluminum	1 Pcs	
NEOLTFP400W6500K	385mm x 395mm x 110mm	400W	6500K	34000LM	175-265V	Dia casting aluminum	1 Pcs	

LED LIGHT - PANEL

LED LIGHT - PANEL



FEATURES:

- Top quality diffusers
- Variety of ranges
- All downlight ranges are with Samsung LED chip
- High quality driver
- Easy to install

LED LIGHT - PANEL



Code	Dimension	Watt	Colour Temperature	Total Lumen	Master Carton	SAMSUNG LED & 02 Years Warranty
NEOLPL060648W6500K	595mm x 595mm x 30mm	48W	6500K	3600LM	1 Box 10 Pcs	
NEOLPL060648W3000K	595mm x 595mm x 30mm	48W	3000K	3600LM	1 Box 10 Pcs	
NEOLPL060636W6500K	595mm x 595mm x 30mm	36W	6500K	3600LM	1 Box 10 Pcs	
NEOLPL060636W3000K	595mm x 595mm x 30mm	36W	3000K	3600LM	1 Box 10 Pcs	

SUNFLOWER SERIES LED DOWNLIGHT LUMINARIE - SQUARE RECESSED PANEL



with SAMSUNG LED & 2 Year Warranty

Code	Dimension	Watt	Colour Temperature	Total Lumen	CUT OUT	Master Carton
NEOLDL022024W6500K	225mm x 24mm	24W	6500K	1920LM	206mm	1 Box 20 Pcs

SUNFLOWER SERIES LED DOWNLIGHT LUMINARIE - ROUND RECESSED PANEL

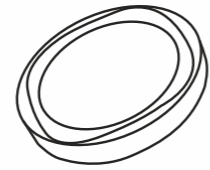

255mm
Depth: 28mm

with SAMSUNG LED & 2 Year Warranty

Code	Dimension	Watt	Colour Temperature	Total Lumen	Master Carton
NEOLDL012124W6500K	255mm x 28mm	24W	6500K	1920LM	1 Box 20 Pcs
NEOLDL012118W6500K	255mm x 28mm	18W	6500K	1440LM	1 Box 20 Pcs

SUNFLOWER SERIES LED DOWNLIGHT LUMINARIE - ROUND RECESSED PANEL

SAVES
80%
ENERGY

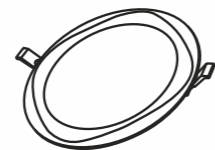

255mm
Depth: 24mm



170mm
Depth: 24mm

Code	Dimension	Watt	Colour Temperature	Total Lumen	Cut Out	Master Carton
NEOLDL012024W6500K	225mm x 24mm	24W	6500K	1920LM	206mm	1 Box 20 Pcs
NEOLDL012024W3000K	225mm x 24mm	24W	3000K	1920LM	206mm	1 Box 20 Pcs
NEOLDL012018W6500K	225mm x 24mm	18W	6500K	1440LM	206mm	1 Box 20 Pcs
NEOLDL012018W3000K	225mm x 24mm	18W	3000K	1440LM	206mm	1 Box 20 Pcs
NEOLDL012012W6500K	170mm x 24mm	12W	6500K	960LM	158mm	1 Box 20 Pcs
NEOLDL012012W3000K	170mm x 24mm	12W	3000K	960LM	158mm	1 Box 20 Pcs

with SAMSUNG LED & 2 Year Warranty

LED DOWNLIGHT LUMINARIE - ROUND RECESSED SLIM PANEL



170mm
Depth: 18mm

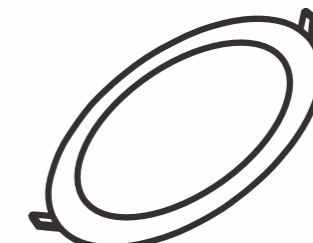

255mm
Depth: 18mm

Code	Dimension	Watt	Colour Temperature	Cut Out	Total Lumen	Master Carton
NEOLDL001018W6500K	225mm x 18mm	18W	6500K	206mm	1260LM	1 Box 20 Pcs
NEOLDL001018W3000K	225mm x 18mm	18W	3000K	206mm	1260LM	1 Box 20 Pcs
NEOLDL001012W6500K	170mm x 18mm	12W	6500K	155mm	840LM	1 Box 30 Pcs
NEOLDL001012W3000K	170mm x 18mm	12W	3000K	155mm	840LM	1 Box 30 Pcs

with SAMSUNG LED & 2 Year Warranty

GALVANIZED STEEL SWITCH & SOCKET BOX



FEATURES:

- Available in 3x3 & 3x6 inch
- Depth of the box 35mm
- 1.1mm and 0.9mm thickness available
- Neox GI box are comply to BS4662

GALVANIZED STEEL SWITCH & SOCKET BOX

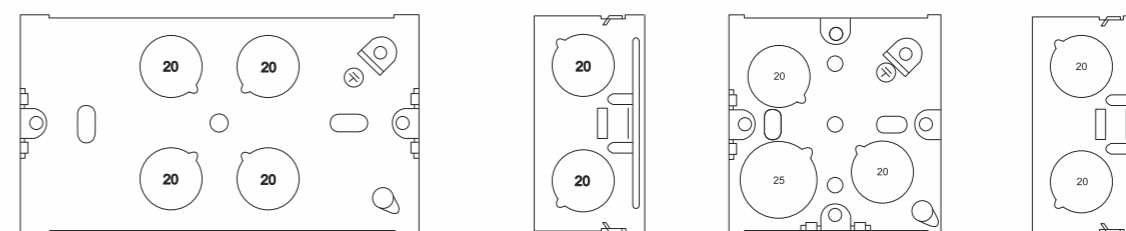

Code	Dimension	Zinc Plating Thickness	No. of adjustable lug	No. of brass terminals	Master Carton
NEONX36350111	3"x6"x35mmx1.1mm	60	2	1	50 Pcs
NEONX36350109	3"x6"x35mmx0.9mm	80	2	1	50 Pcs
NEONX33350311	3"x3"x35mmx1.1mm	60	2	1	100 Pcs
NEONX33350309	3"x3"x35mmx0.9mm	80	2	1	100 Pcs
NEONX33350308	3"x3"x35mmx0.8mm	-	-	-	100 Pcs
NEONX36350308	3"x6"x35mmx0.8mm	-	-	-	100 Pcs

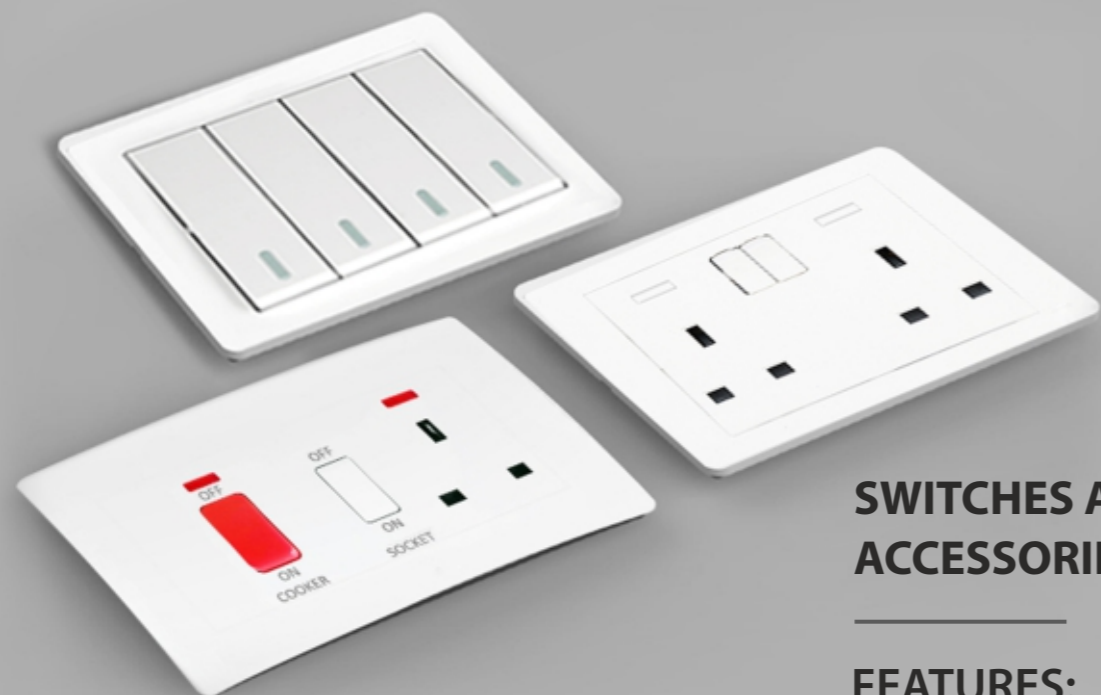

SWITCHES AND WIRING ACCESSORIES

FEATURES:

- Luminous tip on each rocker

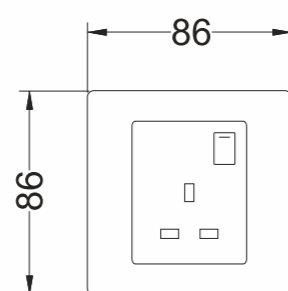

Code	Description	Dimension	Ampere	Material	Master Carton
NEOV027W	1GANG SWITCHED SOCKET OUTLET	86x86mm	250V, 13A	Polycarbonate panel + stainless steel frame & tin-phosphor bronze	100 Pcs

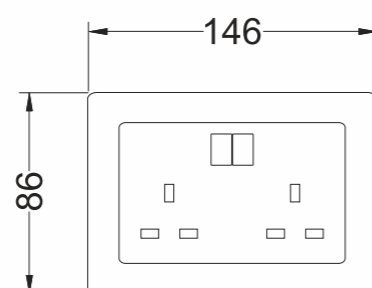
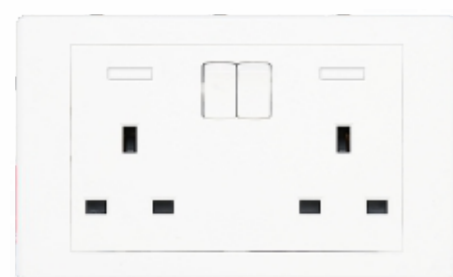

Code	Description	Dimension	Ampere	Material	Master Carton
NEOV029W	2GANG SWITCHED SOCKET OUTLET	86x146mm	250V, 13A	Polycarbonate panel + stainless steel frame & tin-phosphor bronze	60 Pcs

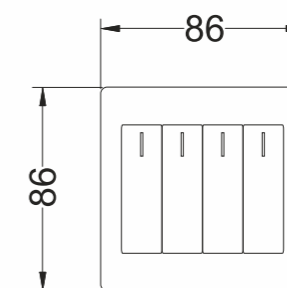

Code	Description	Dimension	Ampere	Material	Master Carton
NEOW008P	4GANG, 2WAY WIDE ROCKER PLATE SWITCH	86x86mm	250V, 10A	Polycarbonate panel + frame and Silver contact + phosphor copper	100 Pcs

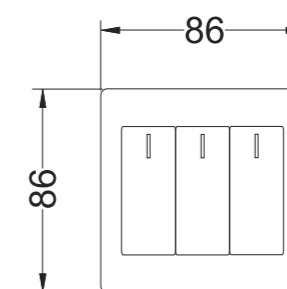

Code	Description	Dimension	Ampere	Material	Master Carton
NEOW006P	3GANG, 2WAY WIDE ROCKER PLATE SWITCH	86x86mm	250V, 10A	Polycarbonate panel + frame and Silver contact + phosphor copper	100 Pcs

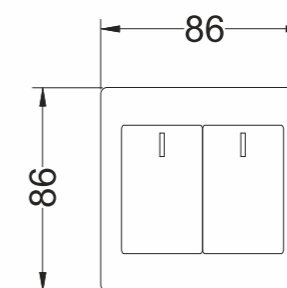

Code	Description	Dimension	Ampere	Material	Master Carton
NEOW004P	2GANG, 2WAY WIDE ROCKER PLATE SWITCH	86x86mm	250V, 10A	Polycarbonate panel + frame and Silver contact + phosphor copper	100 Pcs

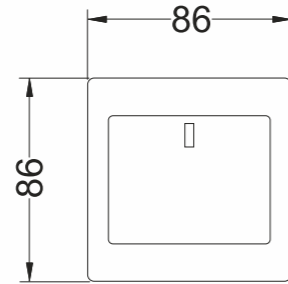
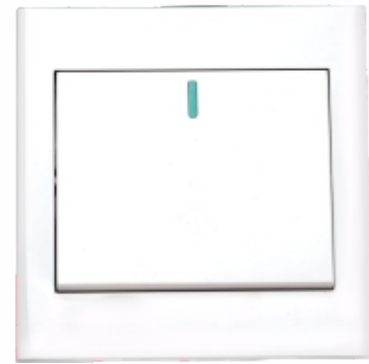

Code	Description	Dimension	Ampere	Material	Master Carton
NEOW002P	1GANG, 2WAY WIDE ROCKER PLATE SWITCH	86x86mm	250V, 10A	Polycarbonate panel frame and Silver contact phosphor copper	100 Pcs

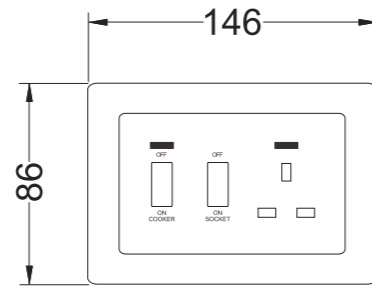

Code	Description	Dimension	Ampere	Material	Master Carton
NEOV043W	COOKER CONTROL UNIT SWITCH WITH NEON	86x146mm	45A	Polycarbonate panel + stainless steel frame and tin-phosphor bronze	60 Pcs

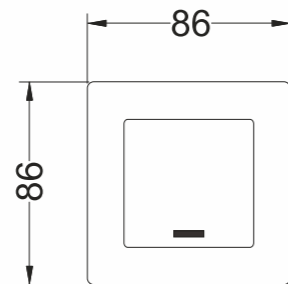

Code	Description	Dimension	Ampere	Material	Master Carton
NEOV039W	1 GANG DP SWITCH WITH INDICATOR	86x86mm	45A	Polycarbonate panel + stainless steel frame and Silver contact + phosphor copper	100 Pcs

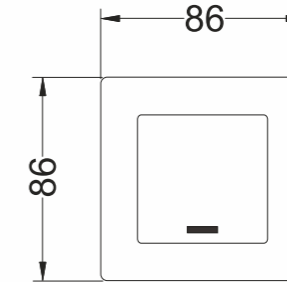

Code	Description	Dimension	Ampere	Material	Master Carton
NEOV038W	1GANG, 2WAY WIDE ROCKER PLATE SWITCH WITH NEON	86x86mm	20A	Polycarbonate panel + stainless steel frame and Silver contact + phosphor copper	100 Pcs

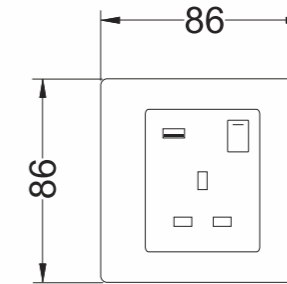

Code	Description	Dimension	Ampere	Material	Master Carton
NEOV036W	1GANG, SWITCH OUTLET WITH USB CHARGING PORT	86x6mm	250V, 13A	Polycarbonate panel + stainless steel frame and tin-phosphor bronze	100 Pcs

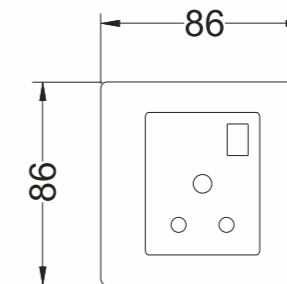
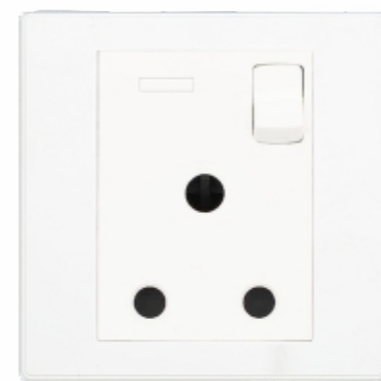

Code	Description	Dimension	Ampere	Material	Master Carton
NEOV031W	1GANG, SWITCHED ROUND PIN SOCKET OUTLET	86x6mm	250V, 15A	Polycarbonate panel + stainless steel frame and tin-phosphor bronze	100 Pcs

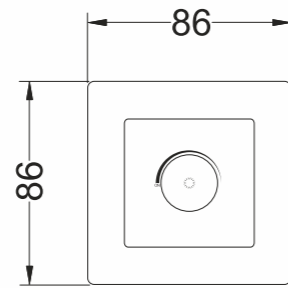

Code	Description	Dimension	Material	Master Carton
NEOV017W	1 GANG DIMMER SWITCH 1000W	86x86mm	Polycarbonate panel + stainless steel frame	80 Pcs

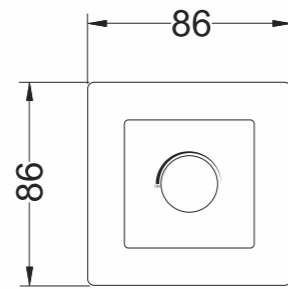

Code	Description	Dimension	Material	Master Carton
NEOV018W	1 GANG FAN CONTROLLER	86x86mm	Polycarbonate panel + stainless steel frame	80 Pcs

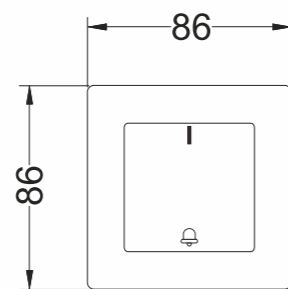

Code	Description	Dimension	Ampere	Material	Master Carton
NEOV024W	1 GANG WIDE ROCKER PLATE BELL PUSH	86x86mm	250V, 10A	Polycarbonate panel + Polycarbonate frame and Silver contact + phosphor copper	100 Pcs

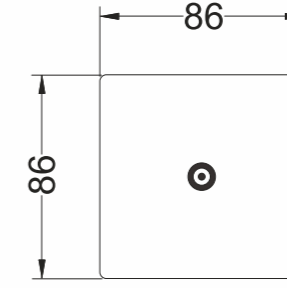
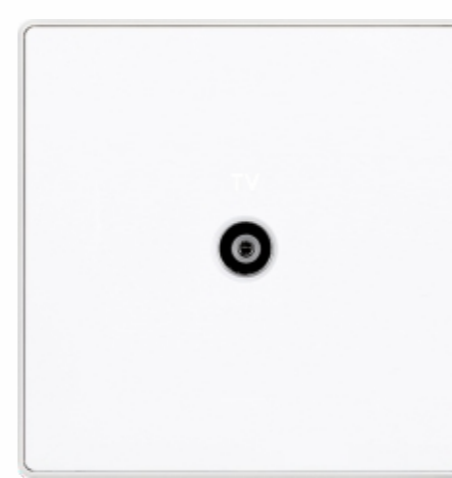

Code	Description	Dimension	Material	Master Carton
NEOV009W	SINGLE CO-AXIAL TV OUTLET	86x86mm	Polycarbonate panel + stainless steel frame	100 Pcs

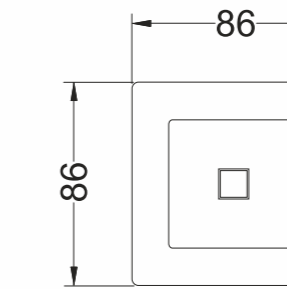
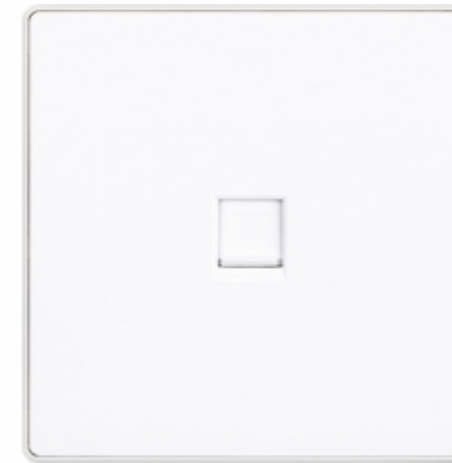

Code	Description	Dimension	Material	Master Carton
NEOV011W	SINGLE DATA OUTLET	86x86mm	Polycarbonate panel + stainless steel frame and Cat 5E	100 Pcs

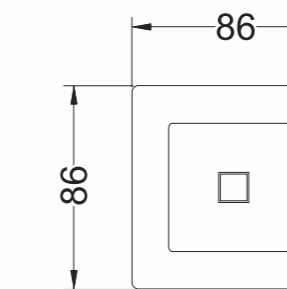
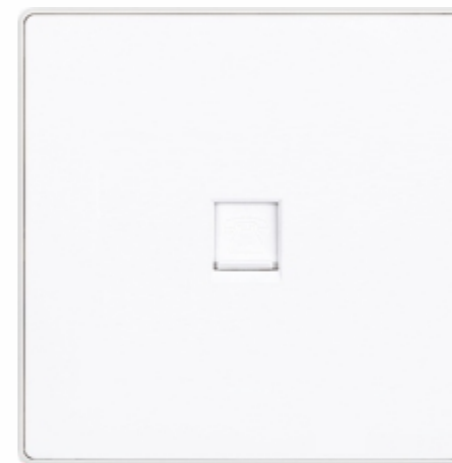

Code	Description	Dimension	Material	Master Carton
NEOV010W	SINGLE TELEPHONE OUTLET	86x86mm	Polycarbonate panel + Polycarbonate frame and Silver contact + phosphor copper	100 Pcs

EXTENSION TRAILING SOCKETS

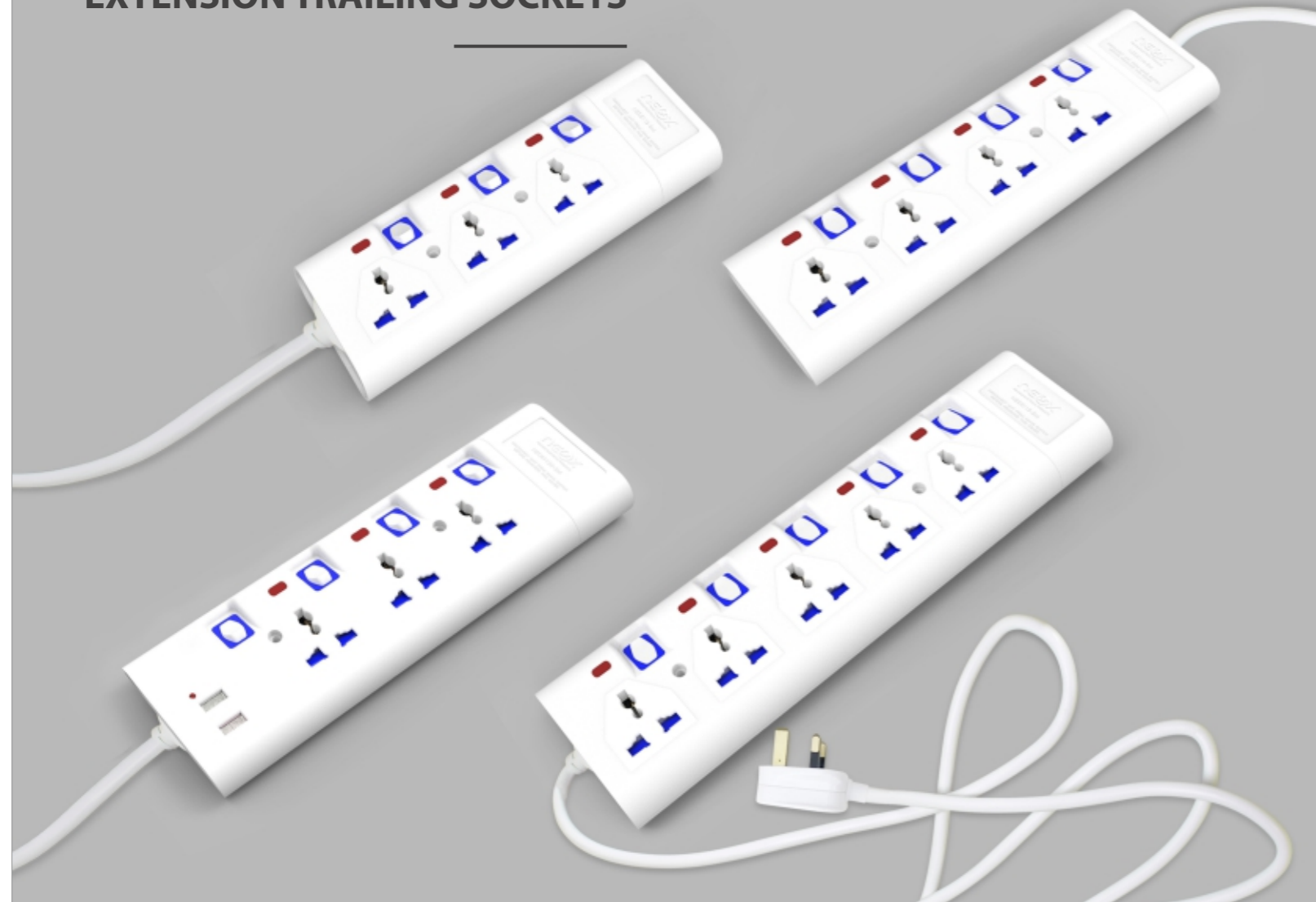

FEATURES:

- High Impact Polycarbonate Surface
- ESMA Approved
- Approved Copper Cable And Component.
- Power Supply Cord With 3 Mtr And 5 Mtr
- Portable switch socket outlet with individual Neon switch
- Available In 3 Gang, 4 Gang, 5 Gang
- Available also with USB
- Plug Type with US, BS, EU, can Apply To Almost All Devices 2pin And 3 Pin.

EXTENSION TRAILING SOCKETS



EXTENSION TRAILING SOCKETS

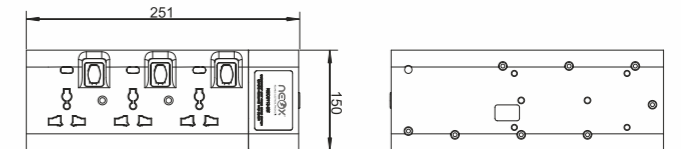
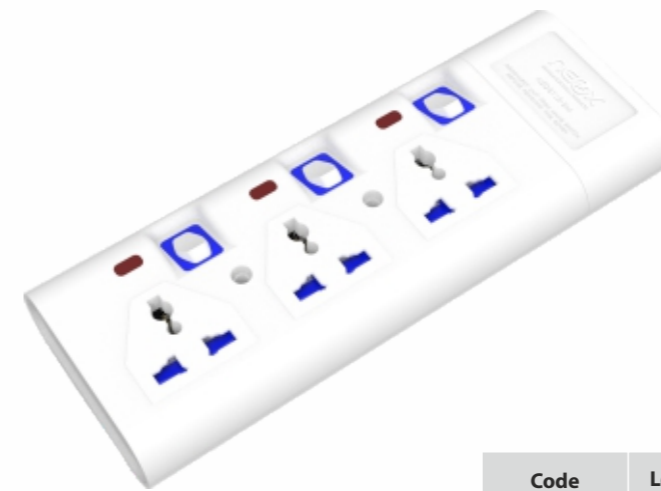

Code	Length	Outlets	USB Port	Material	Warranty	Master Carton
NEO6113-3M	3mtr Cord	3 Way	-	Polycarbonate	02 Years	20 Pcs
NEO6113-5M	5mtr Cord	3 Way	-	Polycarbonate	02 Years	20 Pcs

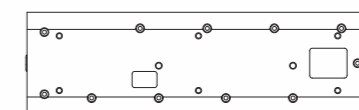
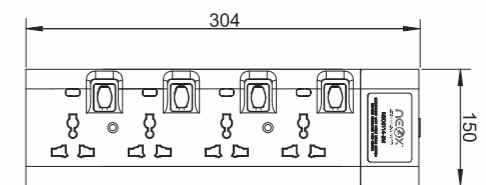
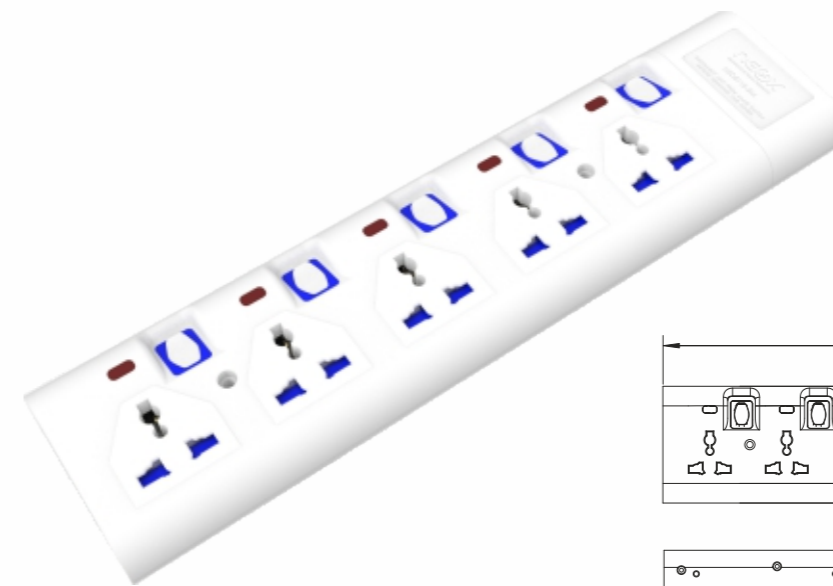

Code	Length	Outlets	USB Port	Material	Warranty	Master Carton
NEO6114-3M	3mtr Cord	4 Way	-	Polycarbonate	02 Years	20 Pcs
NEO6114-5M	5mtr Cord	4 Way	-	Polycarbonate	02 Years	20 Pcs

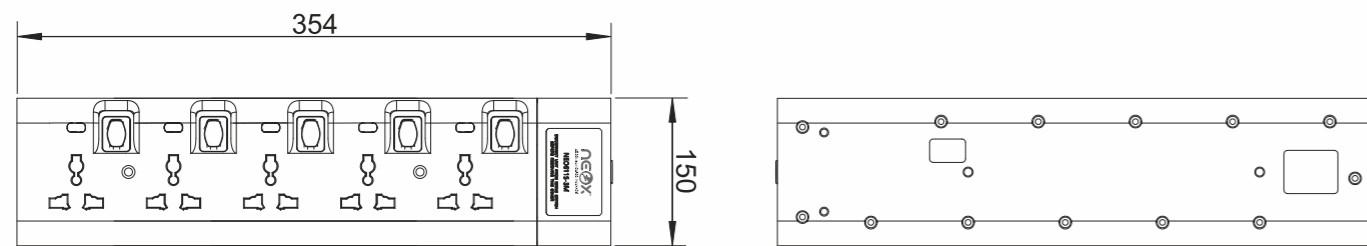
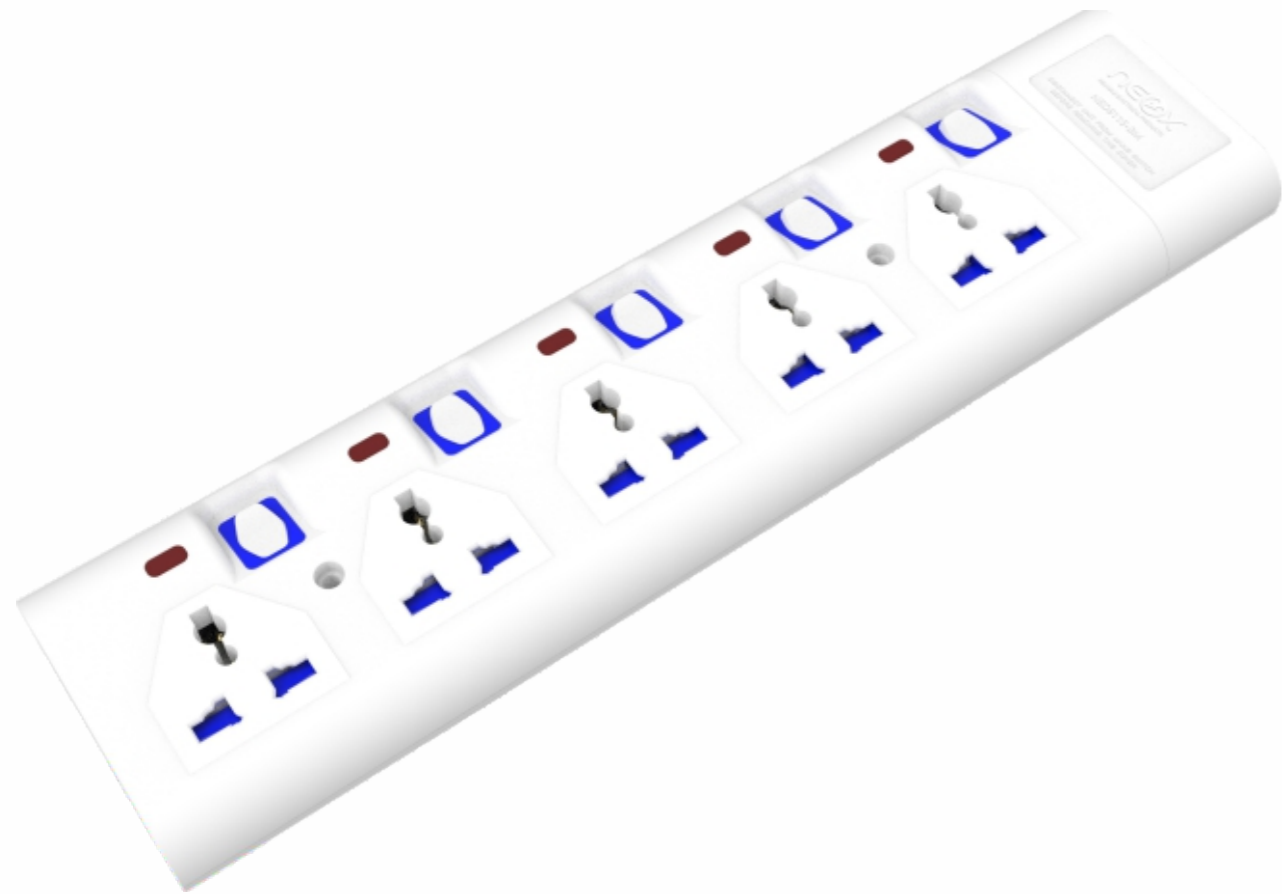

Code	Length	Outlets	USB Port	Material	Warranty	Master Carton
NEO6115-3M	3mtr Cord	5 Way	-	Polycarbonate	02 Years	20 Pcs
NEO6115-5M	5mtr Cord	5 Way	-	Polycarbonate	02 Years	20 Pcs

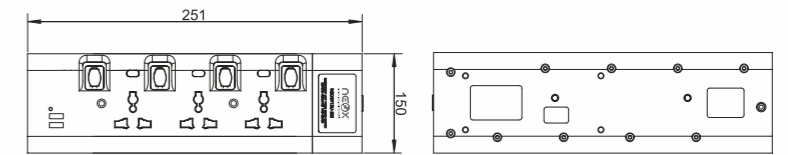
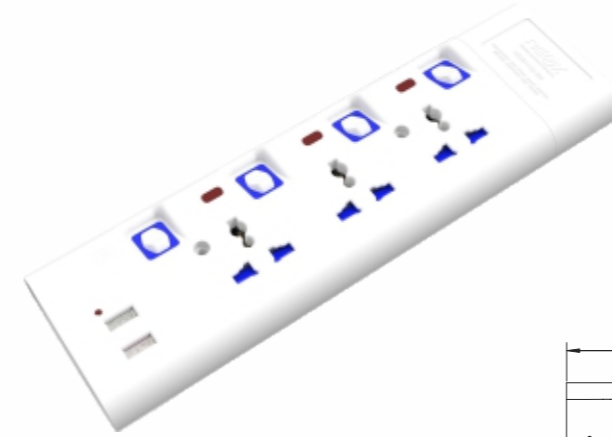

Code	Length	Outlets	USB Port	Material	Warranty	Master Carton
NEO6113U-3M	3mtr Cord	3 Way	02 USB	Polycarbonate	02 Years	20 Pcs

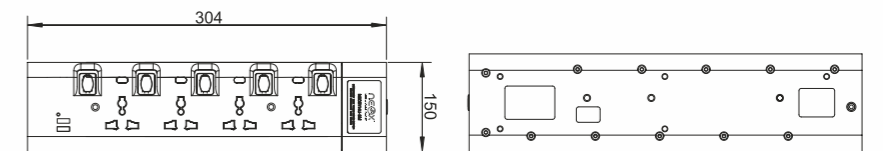
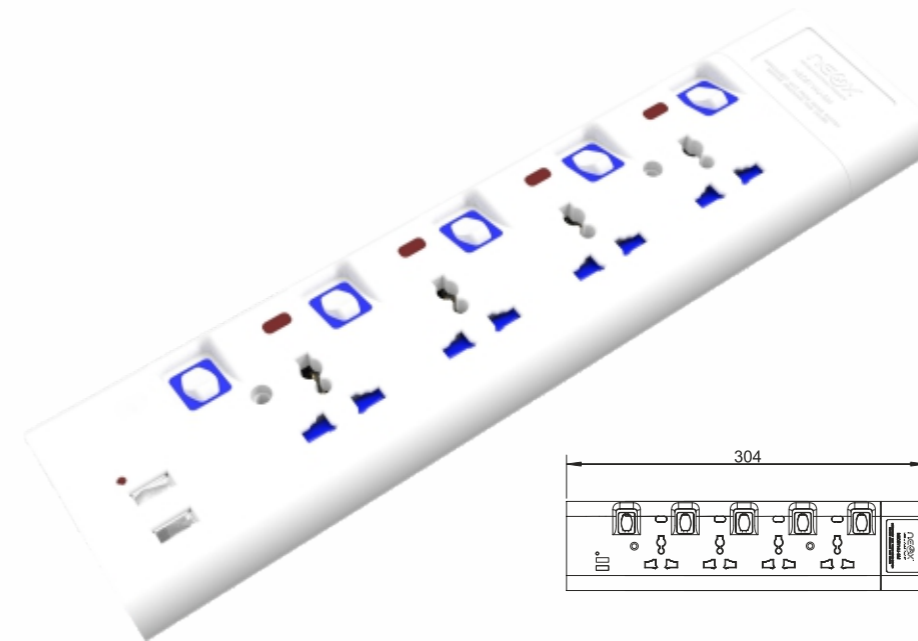

Code	Length	Outlets	USB Port	Material	Warranty	Master Carton
NEO6114U-5M	5mtr Cord	4 Way	02 USB	Polycarbonate	02 Years	20 Pcs

WEATHERPROOF SERIES

FEATURES:

- Clear silicon gasket allows operation of switch without lifting cover
- Large switch rocker allows easy operation
- Mounting screw locations are segregated from back box by gasket for improved IP installations.
- 20mm conduit entries available on all sides.

WEATHERPROOF SERIES IP55 SWITCHES AND SOCKET OUTLETS



WEATHERPROOF SERIES IP55 SWITCHES AND SOCKET OUTLETS

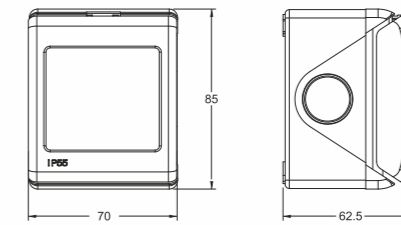

Code	Description	Ampere	Rating	Master Carton
NEOUKW-1GS	WEATHER PROOF 1 GANG, 1 WAY SWITCH	13A/250V	IP55	-

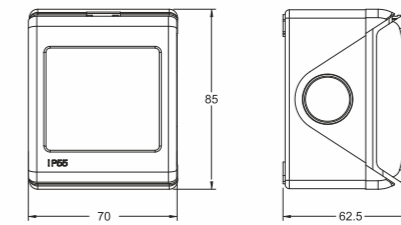

Code	Description	Ampere	Rating	Master Carton
NEOUKW-2GS	WEATHER PROOF 2 GANG, 1 WAY SWITCH	13A/250V	IP55	-

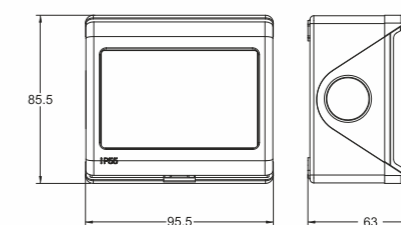

Code	Description	Ampere	Rating	Master Carton
NEOUKW-3GS	WEATHER PROOF 3 GANG, 1 WAY SWITCH	13A/250V	IP55	-

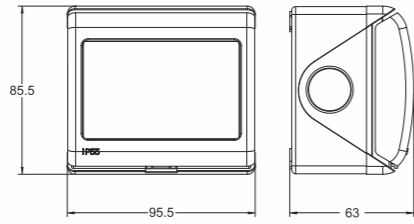

Code	Description	Ampere	Rating	Master Carton
NEOUKW-1GSS	WEATHER PROOF 1GANG SWITCHED SOCKET OUTLET	13A/250V	IP55	-

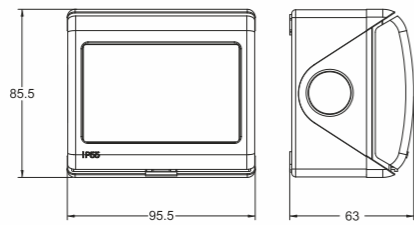

Code	Description	Ampere	Rating	Master Carton
NEOUKW-SSR	WEATHER PROOF ROUND PIN SWITCHED SOCKET OUTLET	15A/250V	IP55	-

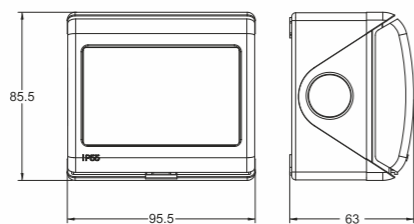

Code	Description	Ampere	Rating	Master Carton
NEOUKW-2S	WEATHER PROOF 2 GANG SOCKET OUTLET	13A/250V	IP55	-

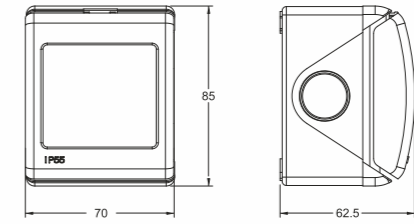

Code	Description	Ampere	Rating	Master Carton
NEOUKW-1GB	WEATHER PROOF 1 GANG BELL PUSH	13A/250V	IP55	-

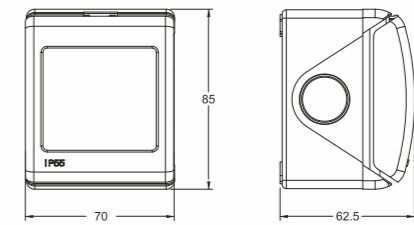

Code	Description	Ampere	Rating	Master Carton
NEOUKW-1GBS	WEATHER PROOF 1 GANG DP SWITCH	20A/250V	IP55	-

Fast Nationwide Delivery



WEATHERPROOF SERIES



FEATURES:

- High level of ingress protection against water jet and dust.
- Polycarbonate construction.
- High impact resistance
- Multiple gland entry position.
- Suitable for outdoor use.

WEATHERPROOF SERIES IP66 SWITCHES AND SOCKET OUTLETS



WEATHERPROOF SERIES IP66 SWITCHES AND SOCKET OUTLETS

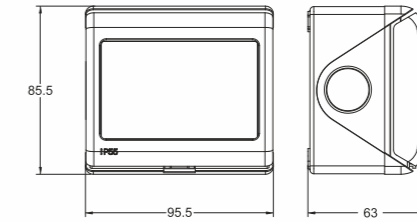

Code	Description	Ampere	Rating	Master Carton
NEOWP302	WEATHERPROOF 1 GANG 2 WAY SWITCH	10A	IP66	-

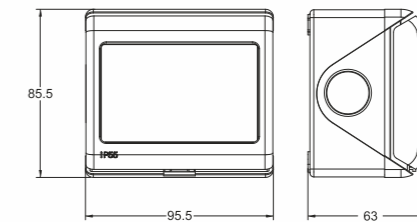

Code	Description	Ampere	Rating	Master Carton
NEOWP304	WEATHERPROOF 2 GANG 2 WAY SWITCH	10A	IP66	-

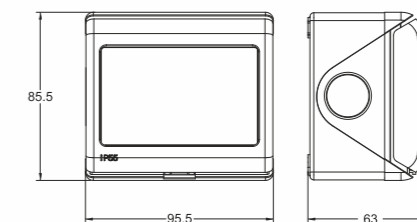

Code	Description	Ampere	Rating	Master Carton
NEOWP317	WEATHERPROOF 1 GANG BELL PUSH	10A	IP66	-

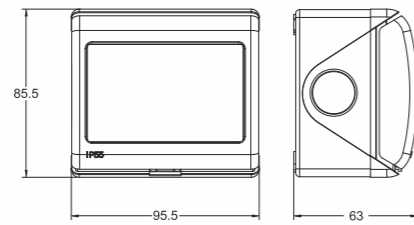

Code	Description	Ampere	Rating	Master Carton
NEOWP324	WEATHERPROOF 1 GANG DP SWITCH	20A	IP66	-

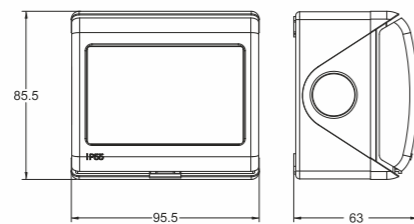

Code	Description	Ampere	Rating	Master Carton
NEOWPZ405	WEATHERPROOF 1 GANG SWITCHED SOCKET OUTLET	13A	IP66	-

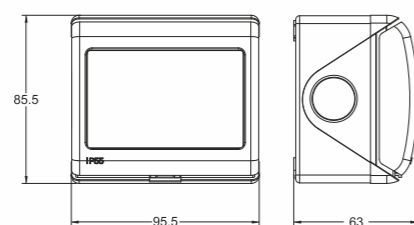

Code	Description	Ampere	Rating	Master Carton
NEOWPZ406	WEATHERPROOF 2 GANG SWITCH SOCKET OUTLET	13A	IP66	-

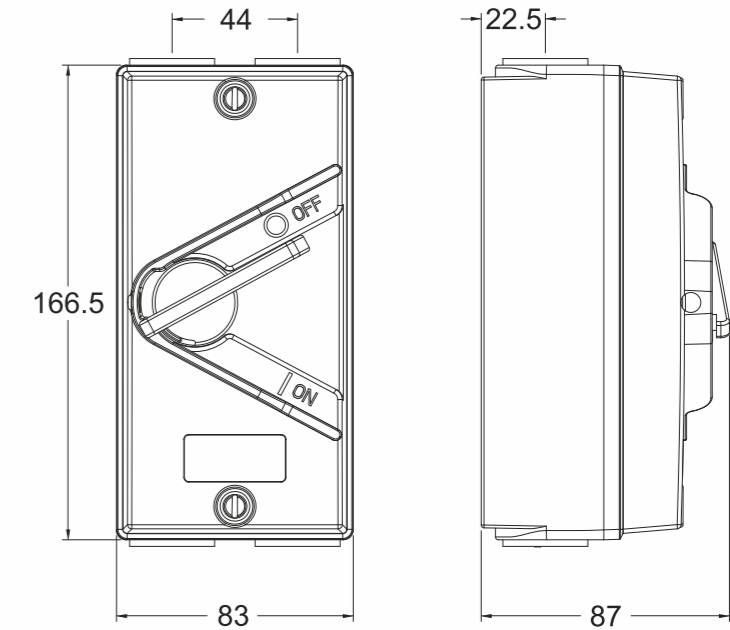

FEATURES:

- Protection degree IP66 prevents dust and powerful waterjets.
- 2 screw cover for easy fixing
- Suitable for surface mounting
- Complete with neutral and earth connection bar
- Virgin Polycarbonate body
- Related voltage 240/415v
- Ampere range 20a, 32a, 63a
- 2P & 3P options

Code	Ampere	Pole	Rating	Master Carton
NEOUKF1-220	20A /250V	2 Pole	M Rating 220. IP 66	-
NEOUKF1-235	32A/250V	2 Pole	M Rating 220. IP 66	-
NEOUKF1-320	20A/415V	3 Pole	M Rating 180. IP 66	-
NEOUKF1-335	32A/415V	3 Pole	M Rating 180. IP 66	-
NEOUKF1-363	63A/415V	3 Pole	M Rating 180. IP 66	-



